

DH-HAC-HDBW2241F-A

2MP Starlight HDCVI IR Dome Camera

HDCVI



- Starlight, 120dB true WDR, 3DNR
- Max. 30fps@1080P
- HD/SD output switchable
- Audio in interface, built-in mic
- 3.6mm fixed lens (2.8mm optional)
- Max. IR length 20m, Smart IR
- IP67, IK10, DC12V±30%



System Overview

Experience 1080P full HD video and the simplicity of reusing existing coaxial infrastructure with HDCVI. The Starlight HDCVI camera with 120dB true WDR presents a high quality image with rich details even in extreme low-light conditions. It offers various motorized/fixed lens models with a multi-language OSD and HD/SD switchable output. Its superior image performance and starlight feature makes the camera an ideal choice for mid to large-size businesses and projects where both highly reliable surveillance and construction flexibility are needed.

Functions

4 Signals over 1 Coaxial Cable

HDCVI technology supports 4 signals to be transmitted over 1 coaxial cable simultaneously, i.e. video, audio*, data and power. Dual-way data transmission allows the HDCVI camera to interact with the HCVR, such as sending control signal or triggering alarm. Moreover, HDCVI technology supports PoC for construction flexibility.

* Audio input is available for some models of HDCVI cameras.

Long Distance Transmission

HDCVI technology guarantees long-distance and real-time transmission without any loss. It supports up to 800m for 1080P Full HD video via coaxial cable, and up to 300m via UTP cable.*

*Actual results verified by real-scene testing in Dahua's test laboratory.

Simplicity

HDCVI technology inherits the born feature of simplicity from traditional analog surveillance system, making itself a best choice for investment protection. HDCVI system can seamlessly upgrade the traditional analog system without replacing existing coaxial cabling. The plug and play approach enables full HD video surveillance without the hassle of configuring a network.

Starlight

With the adoption of high performance sensor, the camera is able to provide incomparable performance even under extreme lowlight environment. The starlight feature allows more details to be captured and accurate color to be recognized at night or in scenes with limited illumination.

Broadcast-quality Audio

Audio information is used as supplementary evidence in video surveillance applications. The HDCVI camera supports audio signal transmission over coaxial cable. In addition, it adopts unique audio processing and transmission technology that best restores source audio and eliminates noise, guaranteeing the quality and effectiveness of collected audio information.

Multi-formats

The camera supports multiple video formats including HDCVI, CVBS and other two common HD analog formats in the market. The four formats can be switched over through OSD menu or by PFM820 (UTC controller). This feature makes the camera to be compatible with not only HCVRs but also most end users' existing HD/SD DVRs.

Wide Dynamic Range

Embedded with industry leading wide dynamic range (WDR) technology, vivid pictures are achieved even in the most intense contrast lighting conditions. True WDR (120dB) optimizes both the bright and dark areas of a scene at the same time to provide usable video.

Advanced 3DNR

3DNR is noise reduction technology that detects and eliminates random noises by comparing two sequential frames. Dahua's advanced 3DNR technology allows remarkable noise reduction with little impact to sharpness, especially under limited lighting condition. Besides, the advanced 3DNR effectively decreases the band width and saves the storage space.

Protection

The camera's outstanding reliability is unsurpassed due to its rugged design. The camera is protected against water and dust with IP67 ranking, making it suitable for indoor or outdoor environments.

The camera complies with an IK10 vandal resistance rating making it capable of withstanding the equivalent of 5 kg (11.02 lbs) of force dropped from a height of 40 cm (15.75 in).

Supporting ±30% input voltage tolerance, this camera suits even the most unstable power supply conditions. Its 4KV lightning rating provides protection against the camera and its structure from the effects of lightning.

Technical Specification

Camera

| | |
|--------------------------|---|
| Image Sensor | 1/2.8" CMOS |
| Effective Pixels | 1920(H)×1080(V), 2MP |
| Scanning System | Progressive |
| Electronic Shutter Speed | PAL: 1/4s~1/100000s NTSC: 1/3s~1/100000s |
| Minimum Illumination | 0.004Lux/F1.6, 30IRE, 0Lux IR on |
| S/N Ratio | More than 65dB |
| IR Distance | Up to 20m (66feet) |
| IR On/Off Control | Auto / Manual |
| IR LEDs | 8 |

Lens

| | |
|----------------------|---------------------------------|
| Lens Type | Fixed lens / Fixed iris |
| Mount Type | Board-in |
| Focal Length | 3.6mm (2.8mm Optional) |
| Max Aperture | F1.6 |
| Angle of View | H: 86.9° (110°) |
| Focus Control | N/A |
| Close Focus Distance | 1200mm (500mm) 47.2" (19.7") |

DORI Distance

*Note: The DORI distance is a "general proximity" of distance which makes it easy to pinpoint the right camera for your needs. The DORI distance is calculated based on sensor specification and lab test result according to EN 62676-4 which defines the criteria for Detect, Observe, Recognize and Identify respectively.

| | DORI Definition | Distance |
|-----------|----------------------|--|
| Detect | 25px/m (8px/ft) | 2.8mm: 39m(128ft) 3.6mm: 55m(180ft) |
| Observe | 63px/m (19px/ft) | 2.8mm: 15m(49ft) 3.6mm: 22m(72ft) |
| Recognize | 125px/m (38px/ft) | 2.8mm: 8m(26ft) 3.6mm: 11m(36ft) |
| Identify | 250ppm (76px/ft) | 2.8mm: 4m(13ft) 3.6mm: 6m(20ft) |

Pan / Tilt / Rotation

| | |
|-------------------|--|
| Pan/Tilt/Rotation | Pan: 0° ~ 60° Tilt: 0° ~ 80° Rotation: 0° ~ 360° |
|-------------------|--|

Video

| | |
|--------------|---|
| Resolution | 1080P (1920×1080) |
| Frame Rate | 25/30fps@1080P, 25/30/50/60fps@720P |
| Video Output | 1-channel BNC high definition video output / CVBS video output (DIP switch) |
| Day/Night | Auto (ICR) / Manual |

| | |
|-----------------|-----------------|
| OSD Menu | Multi-language |
| BLC Mode | BLC / HLC / WDR |
| WDR | 120dB |
| Gain Control | AGC |
| Noise Reduction | 2D / 3D |
| White Balance | Auto / Manual |
| Smart IR | Auto / Manual |

Certifications

| | |
|----------------|---|
| Certifications | CE (EN55032, EN55024, EN50130-4) FCC (CFR 47 FCC Part 15 subpartB, ANSI C63.4-2014) UL (UL60950-1+CAN/CSA C22.2 No.60950-1) |
|----------------|---|

Interface

| | |
|-----------------|-----------------------|
| Audio Interface | 1ch in & Built-in Mic |
|-----------------|-----------------------|

Electrical

| | |
|-------------------|---------------------------|
| Power Supply | 12V DC ±30% |
| Power Consumption | Max. 3.6W (12V DC, IR on) |

Environmental

| | |
|--|--|
| Operating Conditions | -40°C ~ +60°C (-40°F ~ +140°F) / Less than 95% RH * Start up should be done at above-40°C (-40°F) |
| Storage Conditions | -40°C ~ +60°C (-40°F ~ +140°F) / Less than 95% RH |
| Ingress Protection & Vandal Resistance | IP67 & IK10 |

Construction

| | |
|--------------|------------------------------|
| Casing | Aluminium |
| Dimensions | Φ106mm×50.3mm (Φ4.17"×1.98") |
| Net Weight | 0.31kg (0.68lb) |
| Gross Weight | 0.45kg (0.99lb) |

Ordering Information

| Type | Part Number | Description |
|-------------|---------------------------|--|
| 2MP Camera | DH-HAC-HDBW2241FP-A 2.8mm | 2MP Starlight HDCVI IR Dome Camera, PAL |
| | DH-HAC-HDBW2241FP-A 3.6mm | 2MP Starlight HDCVI IR Dome Camera, PAL |
| | DH-HAC-HDBW2241FN-A 2.8mm | 2MP Starlight HDCVI IR Dome Camera, NTSC |
| | DH-HAC-HDBW2241FN-A 3.6mm | 2MP Starlight HDCVI IR Dome Camera, NTSC |
| Accessories | PFA139 | Junction box (For use alone) |
| | PFB204W | Wall mount (For use alone or with PFA152-E pole mount) |
| | PFA152-E | Pole mount (For use with PFB204W junction box) |
| | PFM800-E | Passive HDCVI Balun |
| | PFM321 | 12V 1A Power Adapter |
| | PFM320 | 12V 2A Power Adapter |
| | PFM300 | 12V 2A Power Adapter |

Accessories

Optional:



PFA139
Junction box



PFB204W
Wall mount



PFA152-E
Pole mount



PFM800-E
Passive HDCVI Balun



PFM321
12V 1A Power Adapter



PFM320
12V 2A Power Adapter



PFM300
12V 2A Power Adapter

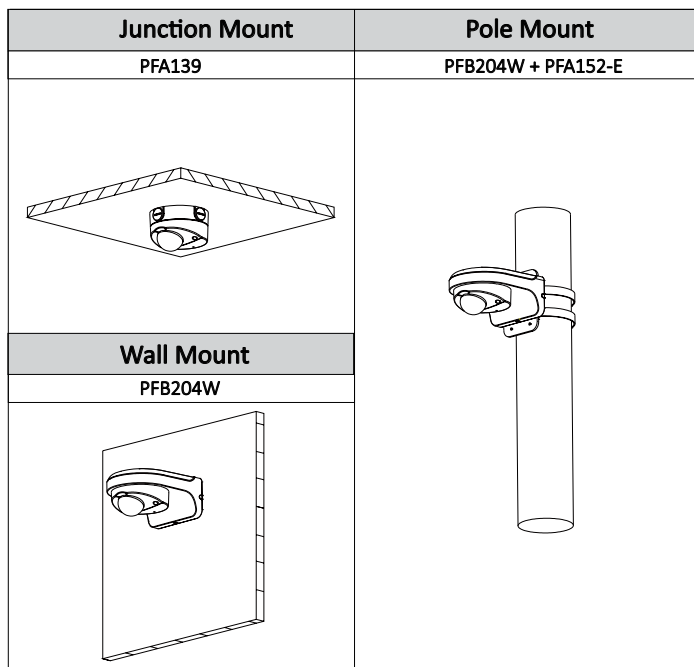

Dimensions (mm/inch)

